

# YAMAHA MX-35

*Natural Sound 2-/4- Channel Dual-Mode Power Amplifier*

*Amplificateur de puissance à deux modes 2/4 canaux de la série "Natural Sound"*

*Natural Sound 2/4-Kanal-Endverstärker*

*Natural Sound 2/4-kanals effektförstärkar*

*Amplificatore di potenza modo duale 2/4 canali a suono natural*

CENTER

**1 MODEL TYPES  
TYPE DE MODELE  
MODELLTYPEN  
MODELLTYPER  
MODELLI**

**General model  
Modèle général  
Allgemeines Modell  
Allmän modell  
Modello generale**

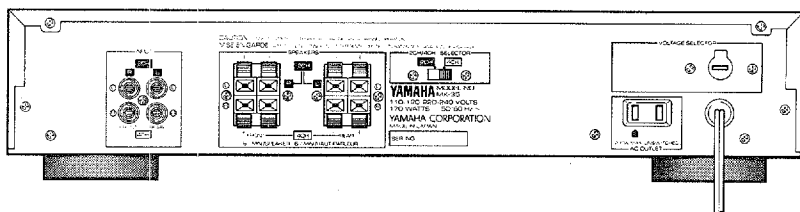

**Australia model  
Modèle pour l'Australie  
Australien-Modell  
Australisk modell  
Modello per Australia**

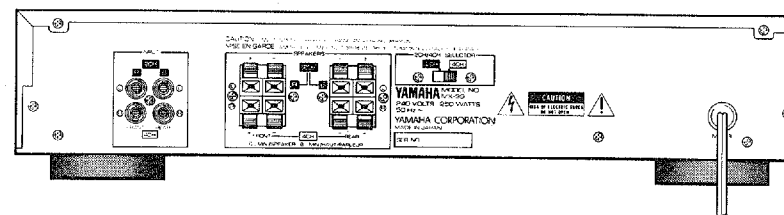

**U.K. and Europe model  
Modèle pour le Royaume-uni et l'Europe  
Großbritannien- und Europa-Modell  
Brittisk och europeisk modell  
Modello per Gran Bretagna e l'Europa**

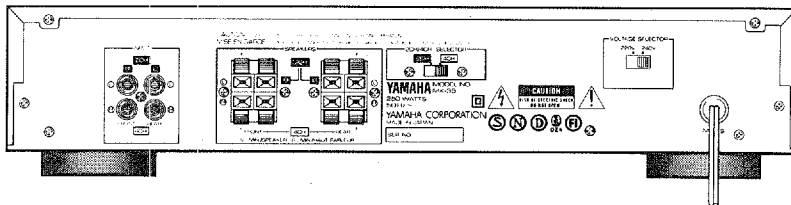

**U.S.A. and Canada model  
Modèle pour les Etats-Unis et le Canada  
USA- und Kanada-Modell  
Amerikansk och kanadensisk modell  
Modello per Stati Uniti e Canada**

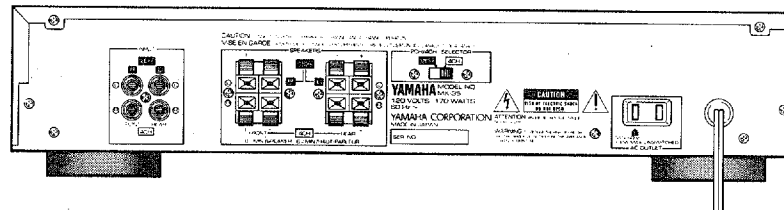

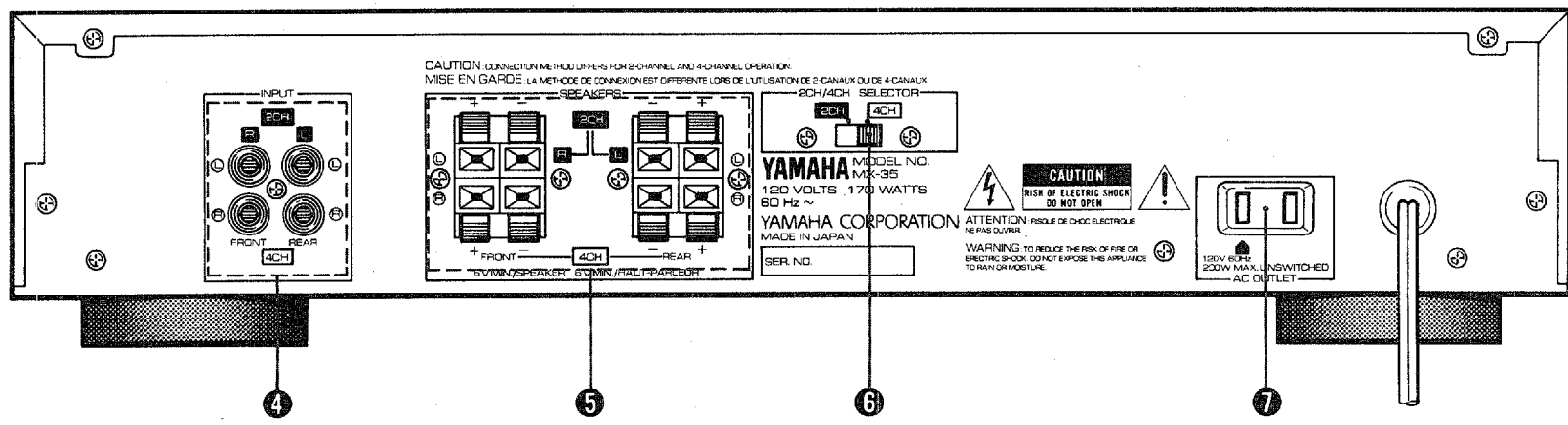
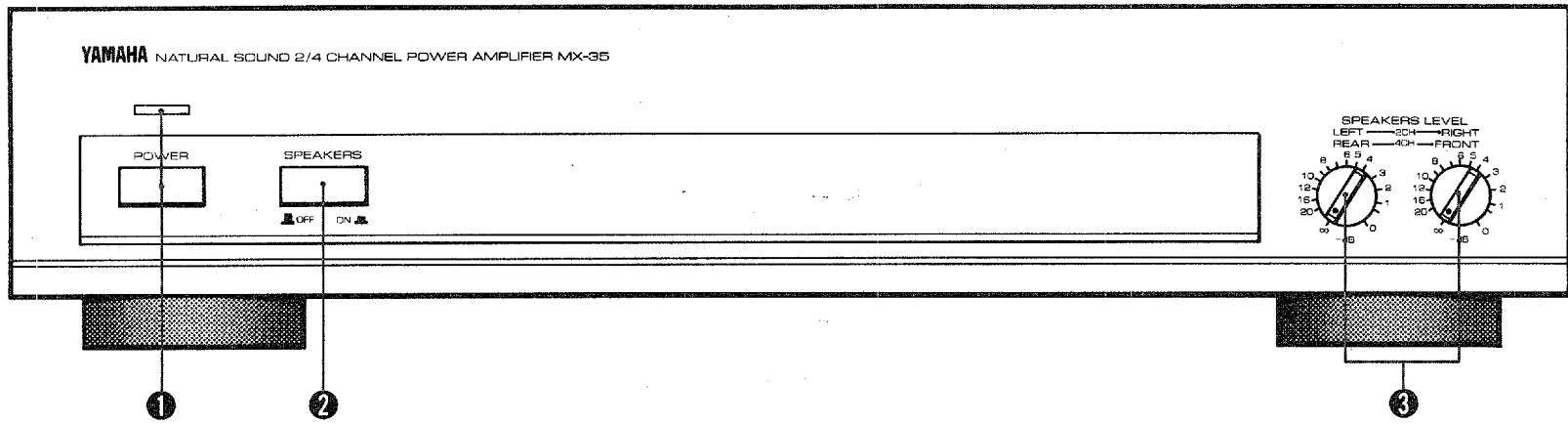

Left-front speaker system  
(separate purchase)  
Enceinte avant gauche  
(achat séparé)  
Vorderer linker Lautsprecher  
(wahlweise)  
Vänster, främre högtalare  
(enskiilt inköp)  
Sistema diffusore anteriore  
sinistro (acquisto separato)

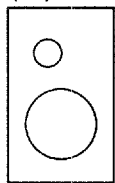

Surround-sound processor  
(separate purchase)  
Processeur sonore d'ambiance  
(achat séparé)  
Raumklangprozessor (wahlweise)  
Kringljudsprocessor (enskiilt inköp)  
Elaboratore suono surround  
(acquisto separato)

INPUT  
Entrée (INPUT)  
EINGANG  
INGÄNG (INPUT)  
ENTRATA

Control amplifier (separate purchase)  
Amplificateur de contrôle (achat séparé)  
Steuerverstärker (wahlweise)  
Kontrollförstärkare (enskiilt inköp)  
Amplificatore di controllo (acquisto separato)

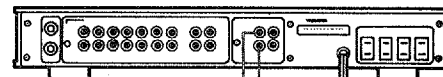

PRE OUT  
Bornes de sortie (PRE OUT)  
Ausgangsbuchsen PRE OUT  
Förstärkare-utgång (PRE)  
PRE OUT

Right-front speaker system  
(separate purchase)  
Enceinte avant droite  
(achat séparé)  
Vorderer rechter Lautsprech  
(wahlweise)  
Höger, främre högtalare  
(enskiilt inköp)  
Sistema diffusore anteriore  
destro (acquisto separato)

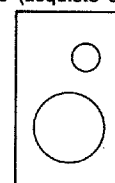

FRONT OUTPUT  
Bornes de sortie avant  
(FRONT OUTPUT)  
Ausgangsbuchsen  
FRONT OUTPUT  
Främre utgångar  
(FRONT OUTPUT)  
PRESA DI USCITA  
ANTERIORE

REAR OUTPUT  
Bornes de sortie arrière  
(REAR OUTPUT)  
Ausgangsbuchsen  
REAR OUTPUT  
Bakre utgångar  
(REAR OUTPUT)  
PRESA DI USCITA  
POSTERIORE

Left-front channel  
Canal avant gauche  
Vorderer linker Kanal  
Vänster, främre kanal  
Canale anteriore sinistro

Left-rear channel  
Canal arrière gauche  
Hinterer linker Kanal  
Vänster, bakre kanal  
Canale posteriore sinistro

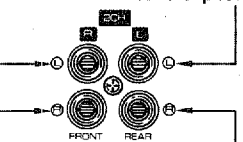

Right-front channel  
Canal avant droit  
Vorderer rechter Kanal  
Höger, främre kanal  
Canale anteriore destro

Right-rear channel  
Canal arrière droit  
Hinterer rechter Kanal  
Höger, bakre kanal  
Canale posteriore destro

Left-front speaker system  
Enceinte avant gauche  
Vorderer linker Lautsprecher  
Vänster, främre högtalare  
Sistema diffusore anteriore  
sinistro

Left-rear speaker system  
Enceinte arrière gauche  
Hinterer linker Lautsprecher  
Vänster, bakre högtalare  
Sistema diffusore posteriore  
sinistro

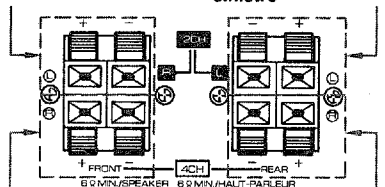

Right-front speaker system  
Enceinte avant droite  
Vorderer rechter Lautsprecher  
Höger, främre högtalare  
Sistema diffusore anteriore  
destro

Right-rear speaker system  
Enceinte arrière droite  
Hinterer rechter Lautsprecher  
Höger, bakre högtalare  
Sistema diffusore posteriore  
destro

Left-rear speaker system  
(separate purchase)  
Enceinte arrière gauche  
(achat séparé)  
Hinterer linker Lautsprecher  
(wahlweise)  
Vänster, bakre högtalare  
(enskiilt inköp)  
Sistema diffusore posteriore  
sinistro (acquisto separato)

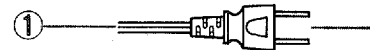
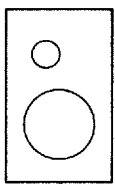

Wall AC outlet  
Prise c.a.  
Netzsteckdose  
Vägguttag  
Presa a muro C.



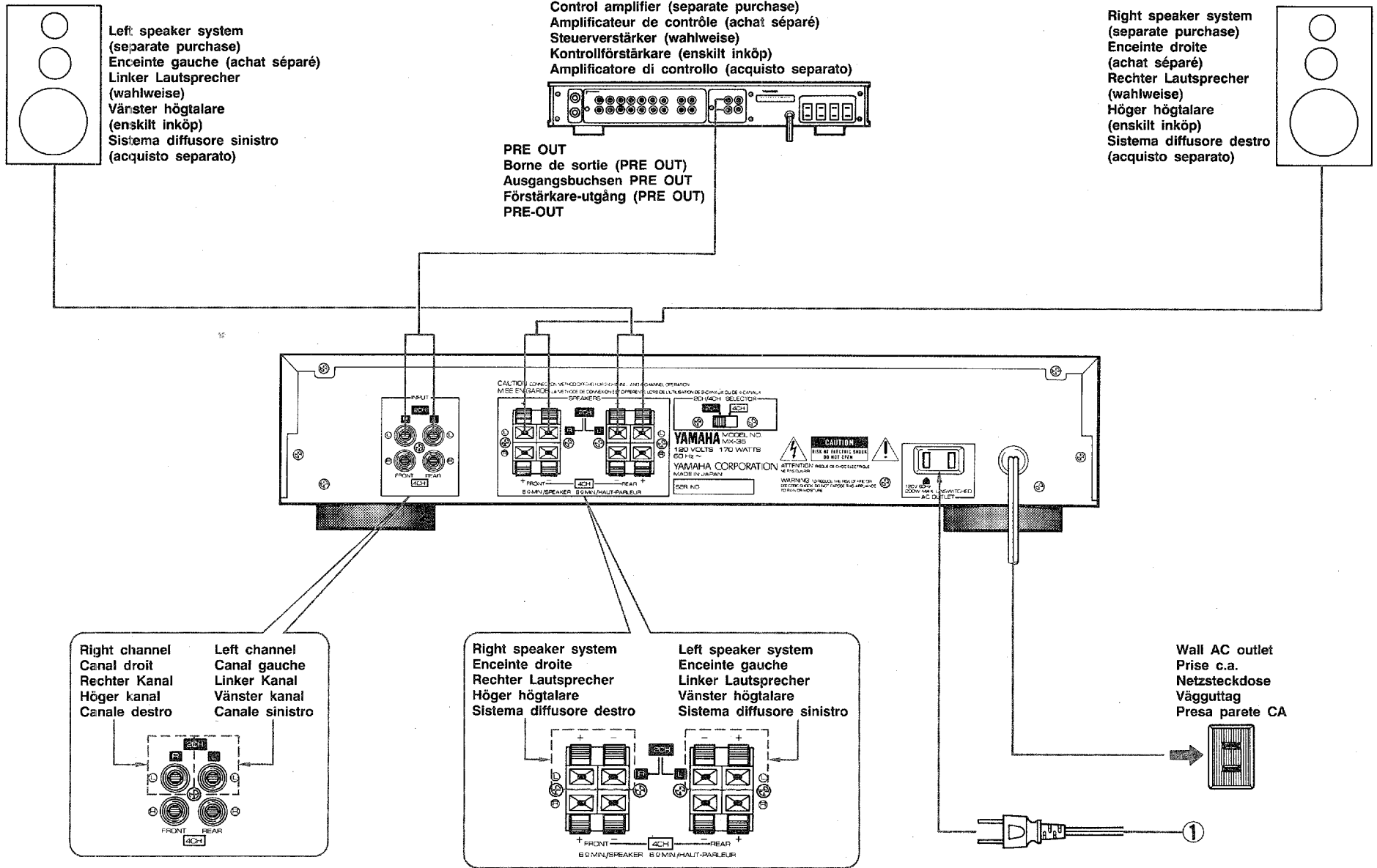

● Thank you for purchasing the YAMAHA MX-35 power amplifier.

**CAUTION: READ THIS BEFORE OPERATING YOUR MX-35**

- 1 To ensure the finest performance, please read this manual carefully. Keep it in a safe place for future reference.
- 2 Install your unit in a cool, dry, clean place – away from windows, heat sources, and too much vibration, dust, moisture or cold. Avoid sources of hum (transformers, motors). To prevent fire or electrical shock, do not expose to rain and water.
- 3 Never open the cabinet. If a foreign object drops into the set, contact your dealer.
- 4 Do not use force on switches, knobs or cords. When moving the set, first turn the unit off. Then gently disconnect the power plug and the cords connecting to other equipment. Never pull the cord itself.
- 5 Always set the volume control of the control amplifier to “ ” while lowering the tonearm to play a record; turn the volume up with the stylus in the groove.
- 6 Do not attempt to clean the unit with chemical solvents; this might damage the finish. Use a clean, dry cloth.
- 7 Be sure to read the “Troubleshooting” section on common operating errors before concluding that your unit is faulty.
- 8 Grounding or polarization — The precautions should be taken so that the grounding or polarization of an appliance is not defeted.

- 9 Do not connect audio equipment to the AC outlet (General, U.S.A and Canada models) on the rear panel if that equipment requires more power than the outlet is rated to provide. (Fig. 1 )
10. If your unit has a voltage selector (General, Europe and U.K. models), check that it is set to your local voltage before you plug it in. If not properly set, reset the switch to indicate your supply voltage. (Fig. 1 )

**IMPORTANT!**

Please make a note of the serial number of this unit in the space indicated below.

Model: MX-35  
Serial no:

The serial number can be found on the rear panel of this unit.  
Keep this Owner's Manual in a safe place for future reference.

**WARNING**

TO PREVENT FIRE OR ELECTRICAL SHOCK,  
DO NOT EXPOSE THIS APPLIANCE TO RAIN  
OR MOISTURE.

**CAUTION**

TO PREVENT ELECTRIC SHOCK DO NOT  
USE THIS (POLARIZED) PLUG WITH AN  
EXTENSION CORD RECEPTACLE OR OTHER  
OUTLET UNLESS THE BLADES CAN BE  
FULLY INSERTED TO PREVENT BLADE  
EXPOSURE.

**SPECIAL INSTRUCTIONS FOR U.K. MODEL**

**IMPORTANT**

The wires in the mains lead are coloured in accordance with the following code.

Blue: NEUTRAL  
Brown: LIVE

As the colours of the wires in the mains lead of this apparatus may not correspond with the coloured markings identifying the terminals in your plug, proceed as follows. The wire which is coloured BLUE must be connected to the terminal which is marked with the letter N or coloured BLACK. The wire which is coloured BROWN must be connected to the terminal which is marked with the letter L or coloured RED.

## CONTROLS AND THEIR FUNCTIONS

(See Fig. 2.)

### FRONT PANEL

#### ❶ POWER switch/indicator (POWER)

Press this switch to switch ON the power. The indicator above it will illuminate while the power is ON.

Press the switch again to switch OFF the power. Note the following cautions.

- Before switching ON the power, be sure to set the volume control(s) of other components (such as the control amplifier, surround-sound processor, etc.) to the lowest setting in order to avoid damage to the speakers.
- The speaker-protection circuit functions to mute speaker sound reproduction for a few seconds after the power is switched ON.

#### ❷ SPEAKERS switch (SPEAKERS ON/OFF)

Sound is reproduced through the speaker systems connected to this unit when this switch is pressed inward. No sound is reproduced when the switch is pressed again to release it outward.

#### ❸ SPEAKERS LEVEL controls (SPEAKER LEVEL)

These controls are used for adjustment of the volume level of the sound reproduced through the speaker systems connected to this unit. Turning a control clockwise increases the volume level from the speaker system(s) corresponding to that control.

Note that the function of these controls differs depending upon whether the unit is being used for 2-channel operation or 4-channel operation, as follows.

##### (1) Two-channel operation:

The control at the right is used to adjust the volume of sound from the right speaker system, and the control at the left is for the left speaker system.

##### (2) Four-channel operation:

The control at the right is used to adjust the volume of sound from the front speaker systems, and the control at the left is for the rear speaker systems.

- Note that, for four-channel operation, these controls cannot be used for adjustment of the left/right balance of the sound. If such an adjustment is necessary, it should be made by using the control on the control amplifier.

- Normally, during 4-CHANNEL operation, these controls should be set to the fully clockwise (0 dB) position, and then the left control should be turned counterclockwise if it is necessary to make an adjustment of the front/rear balance of the sound.
- To make an overall adjustment of the level of the sound, do so by using the control on the control amplifier.

### REAR PANEL

#### ❹ INPUT terminals

These terminals are for connections from a control amplifier, surround-sound processor, etc. Note that the connections differ depending upon whether this unit is to be used for two-channel operation or four-channel operation.

- Refer to the section "CONNECTIONS" for detailed information.

#### ❺ SPEAKERS terminals

These terminals are for connections to the speaker systems. Just as for the INPUT terminals, note that the connections differ depending upon whether this unit is to be used for two-channel operation or four-channel operation.

- Refer to the section "CONNECTIONS" for detailed information.

#### ❻ 2-/4-CHANNEL selector (2CH/4CH SELECTOR)

Set this selector to the "2CH" position if the unit is to be used for two-channel operation, or to the "4CH" position for four-channel operation.

#### ❼ UNSWITCHED AC outlet

This unswitched AC outlet can be used for connection of the power cord from another audio component. Note that the power to that component is not affected by the ON or OFF setting of the POWER switch of this unit.

**Note:** The component connected here should have a rating of no more than 200W.

## CONNECTIONS

- Before attempting to make any connections to or from this unit, be sure to first switch OFF the power to this unit and to any other components to which connections are being made.
- Note that the arrangement of connections differs depending upon whether this unit is to be used for two-channel operation or four-channel operation.

### CONNECTIONS FOR 4-CHANNEL OPERATION (See Fig. 3.)

1. Set the 2-/4-CHANNEL selector to the "4CH" position.
  2. Make connections from the "PRE OUT" terminals of a control amplifier to the "INPUT" terminals of a surround-sound processor, and then from the "FRONT OUTPUT" terminals of the surround-sound processor to the left pair of "INPUT" terminals of this unit, and from the "REAR OUTPUT" terminals of the surround-sound processor to the right pair of "INPUT" terminals of this unit, as illustrated on page 5.
  3. Then make the connections from this unit to the speaker systems.
    - Make connections from the upper left pair of speaker terminals on this unit to the left front speaker system.
    - Make connections from the lower left pair of speaker terminals on this unit to the right front speaker system.
    - Make connections from the upper right pair of speaker terminals on this unit to the left rear speaker system.
    - Make connections from the lower right pair of speaker terminals on this unit to the right rear speaker system.
- \* Be sure all connections are to the correct respective positive ("+") and negative ("-") terminals of the speaker systems.
- \* Concerning the connections of other components, refer to the Owner's Manual for each component.

#### ① AC outlet

A maximum of 200W can be supplied to another component connected here. Note that this outlet is "unswitched" (i.e., is not affected by the POWER switch of this unit).

### CONNECTIONS FOR 2-CHANNEL OPERATION (See Fig. 4.)

1. Set the 2-/4-CHANNEL selector to the "2CH" position.
  2. Make connections from the "PRE OUT" terminals of a control amplifier to the upper pair of "INPUT" terminals of this unit, as illustrated on page 6.
  3. Then make the connections from this unit to the speaker systems.
- \* Be sure all connections are to the correct respective positive ("+") and negative ("-") terminals of the speaker systems.
- \* Concerning the connections of other components, refer to the Owner's Manual for each component.

#### ① AC outlet

A maximum of 200W can be supplied to another component connected here. Note that this outlet is "unswitched" (i.e., is not affected by the POWER switch of this unit).



## SPEAKER CONNECTIONS

1. Strip off about 10 mm (3/8 in.) of the insulation (leaving only the core wire) from the end of each speaker connection wire to be connected to this unit.
2. Press the lever above one of the SPEAKER connection terminals and insert this exposed core wire into the hole, as shown in the illustration. When the lever is then released, the cord is locked in securely.

Red: positive (+)  
Black: negative (-)

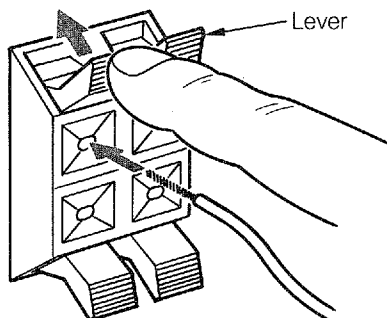

The speaker connection wires should be no longer than necessary.

- \* Be sure that the connection wires are each connected to the speaker system that corresponds to that terminal.
- \* Note that there are two terminals (one positive and one negative) for each speaker system cabinet. The red terminal must be connected to the positive (+) terminal on the speaker system, and the black terminal to the negative (-) terminal on the speaker system. If connections are not correct, the sound reproduced from the speaker systems will seem unnatural, with insufficient stereo effect, sound will seem localized between the speaker systems, and low-range sound will be unsatisfactory.
- \* Be sure that the impedance of the speaker systems is within the specified range for this unit.
- \* When making connections, be sure that the exposed part of the speaker connection wire does not contact two terminals at the same time.

## TROUBLESHOOTING

If the unit fails to operate normally, check the following points to determine whether the problem can be corrected by the simple measures suggested. If it cannot, or if the problem is not listed in the SYMPTOM column, disconnect the unit's power cord and contact your dealer or service center for assistance.

Symptom	Probable Cause	Remedy
<b>The power is not switched ON when the POWER switch is pressed.</b>	The power cord plug is not connected securely to the wall power outlet.	Connect it securely.
<b>No sound is heard.</b>	The SPEAKERS switch is released outward to the "OFF" position.	Press it inward to the "ON" position.
	The SPEAKER LEVEL controls are set all the way to the "∞" position.	Turn them clockwise.
	The connection cords are not connected securely to the INPUT jacks.	Connect them securely.
	The speaker systems are not properly connected to this unit.	Connect them correctly.
<b>No sound is heard from the front and/or rear speaker systems, or from the left and/or right speaker systems.</b>	The speaker systems are not properly connected to this unit.	Connect them correctly.
	One of the SPEAKER LEVEL controls is set to the fully counterclockwise position.	Turn that SPEAKER LEVEL control clockwise.
	The 2-/4-CHANNEL selector is not set to the correct position.	Set it correctly.
<b>The balance between the left and right cannot be adjusted during four-channel operation.</b>	During four-channel operation, the left/right balance adjustment cannot be made by using the controls on this unit.	Make the adjustment by using the controls on the control amplifier.
<b>The acoustic "image" is unstable, characterized by unnatural sound and insufficient low-range tonal quality.</b>	The positive (+) and negative (-) polarities (of this unit and the speaker systems) are not matched.	Reconnect the speaker systems to this unit so that the polarities are aligned.
<b>Hum noise is heard from the speakers.</b>	The connection cords are not connected securely to the INPUT jacks.	Connect them securely.

## SPECIFICATIONS

### Rated outputs

#### Minimum RMS output power per channel

2 CH (20 Hz – 20 kHz)	
0.05% THD, 8 ohms	40W
0.06% THD, 6 ohms (Except U.K., Australia and Europe models)	43W
4 CH (20 Hz – 20 kHz)	
0.07% THD, 8 ohms	20W
0.08% THD, 6 ohms (Except U.K., Australia and Europe models)	22W

### Dynamic Power per channel

2 CH (1 kHz, 8 ohms/6 ohms)	57W/70W
4 CH (1 kHz, 8 ohms/6 ohms)	32W/37W

### DIN standard output power per channel (Except general, U.S.A and Canada models)

4 CH (1 kHz, 1% THD, 4 ohms)	28W
------------------------------	-----

### Dynamic Headroom

2 CH (8 ohms)	1.54 dB
4 CH (8 ohms)	2.04 dB

### Power Bandwidth

2 CH (0.18% THD, 20W/8 ohms)	10 Hz – 50 kHz
4 CH (0.18% THD, 10W/8 ohms)	10 Hz – 40 kHz

### Damping Factor (1 kHz, 8 ohms)

	70
--	----

### Input Sensitivity/Input Impedance

2 CH	1.0V/20 k-ohms
4 CH	0.7V/20 k-ohms

### Frequency Response (20 Hz – 20 kHz)

	+0/-0.3 dB
--	------------

### Total Harmonic Distortion

2 CH (1 kHz, 20W/8 ohms)	0.008%
4 CH (1 kHz, 10W/8 ohms)	0.015%

### Signal-to-Noise Ratio (IHF-A-Network, input short-circuit)

2 CH	120 dB
4 CH	113 dB

### Residual Noise (IHF-A-Network)

(Except general, U.S.A and Canada models)	18 $\mu$ V
---	------------

### Channel Separation

#### (1 kHz, vol. -30 dB, 5.1 k-ohms terminated)

2 CH	70 dB
4 CH	55 dB

### Rated Supply Consumption

Europe and U.K. models	220/240V, 50 H
General model	110/120/220/240V, 50/60 H
Australia model	240V, 50 H
U.S.A and Canada model	120V, 60 H

### Rated Power Consumption

General, U.S.A and Canada models	170W
Europe, U.K. and Australia models	250W

### AC Outlet (Except Europe, U.K. and Australia models)

UNSWITCHED x 1	200W max
----------------	----------

### Dimensions (W x H x D)

	435 x 92.5 x 286.7 mm (17-1/8" x 3-11/16" x 11-5/16")
--	--

### Weight

	5.0 kg (11 lbs)
--	-----------------

\* Please note that the design and all specifications are subject to change without notice.

**YAMAHA**  
HAMAMATSU, JAPAN